

Cellbedell NU1 - G2s

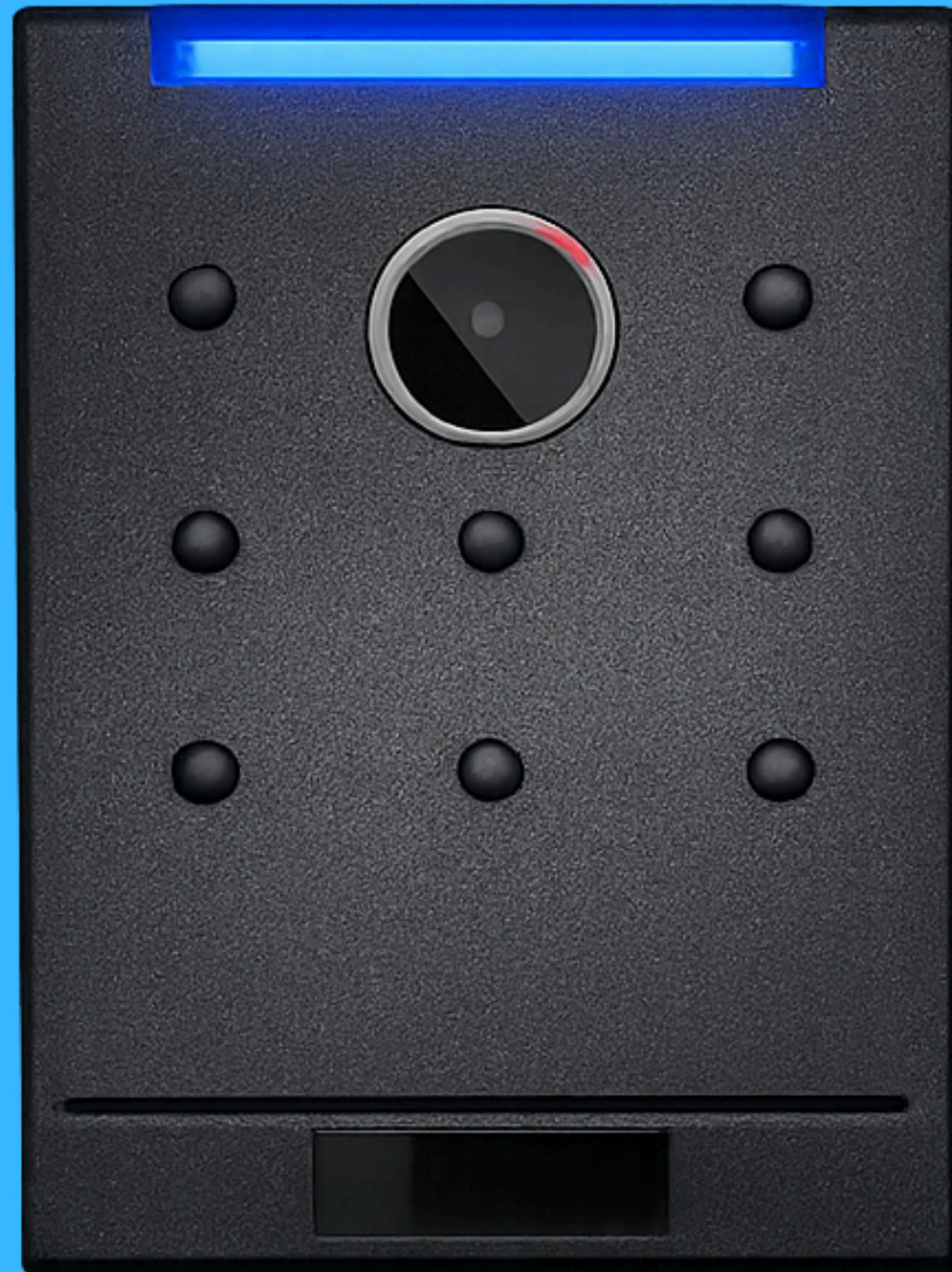

Reader

Edge AI 即時辨識

Plug and play deployment 無需主機

Work both stand alone and remote

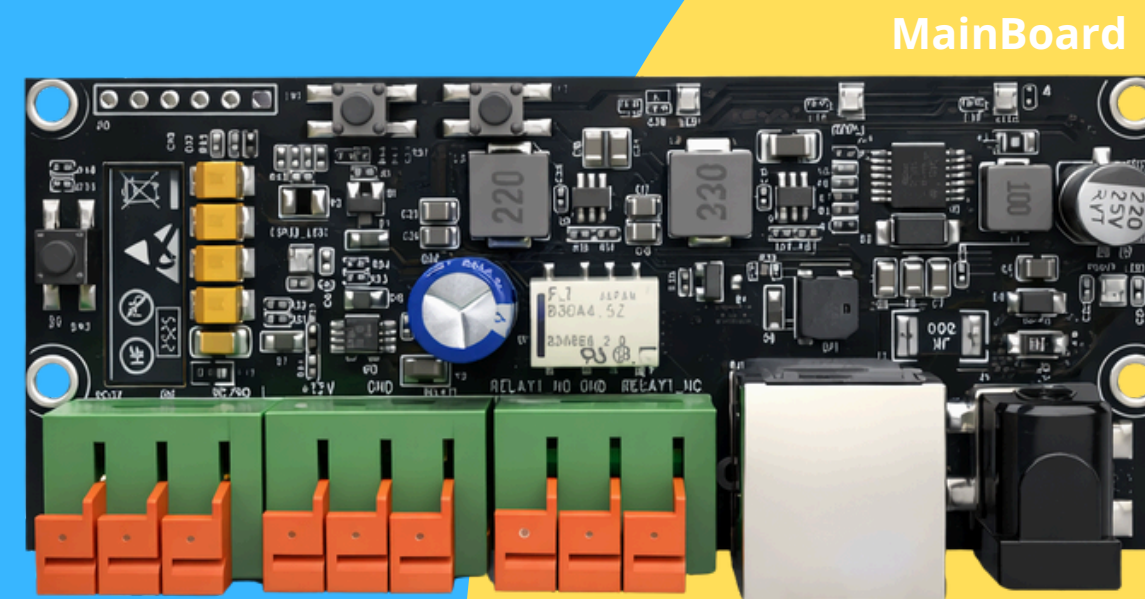

規格

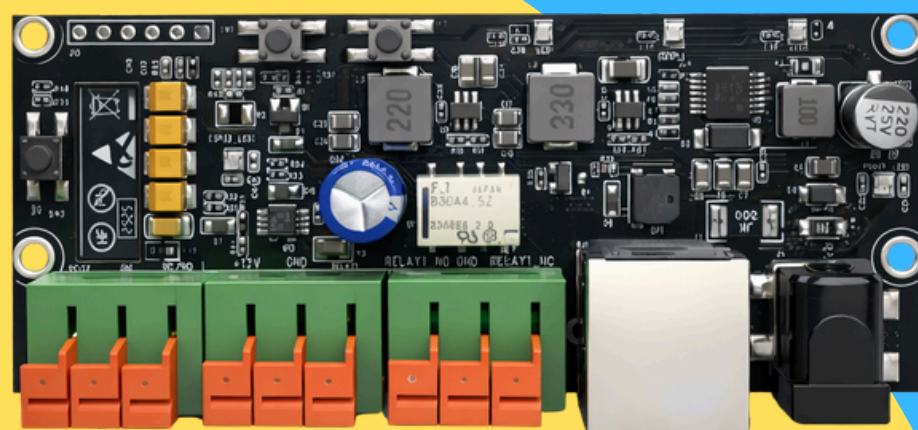

功能	NU1Main Board Generation 2s
wifi模組	wifi模組/遠端設定，更新時間，解鎖
Power	12V/2A
帶電繼電器	電子控制元件 / 12V
不帶電繼電器	電子控制元件
手勢開關	手勢開關連接座
POE	POE前板連接座

System Reset

長按，功能為刪除所有資料

POE

連接前板PCB

Wifi Reset

重啟wifi模組

+12V

input



Wave-to-Open Exit Switch



Relay signal output



COM with power +12V. (output)

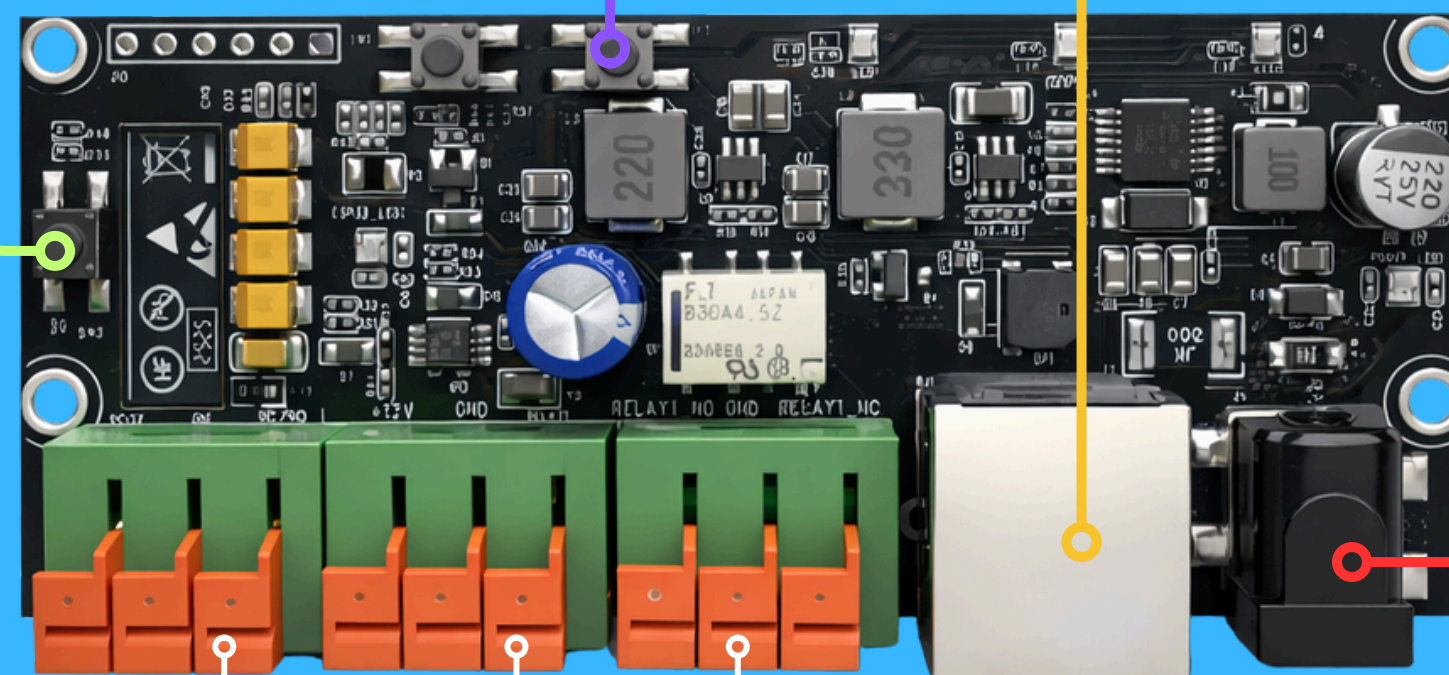

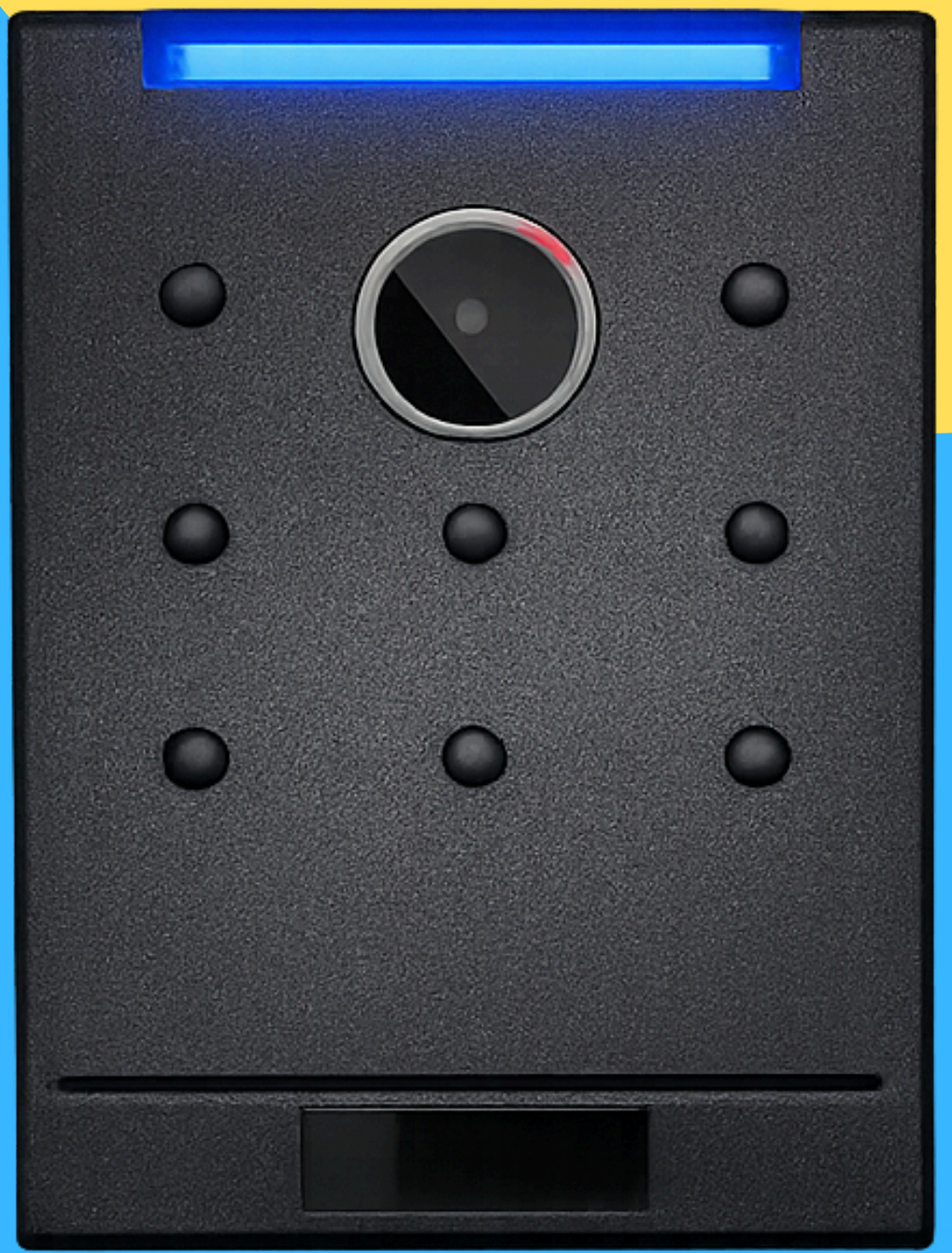
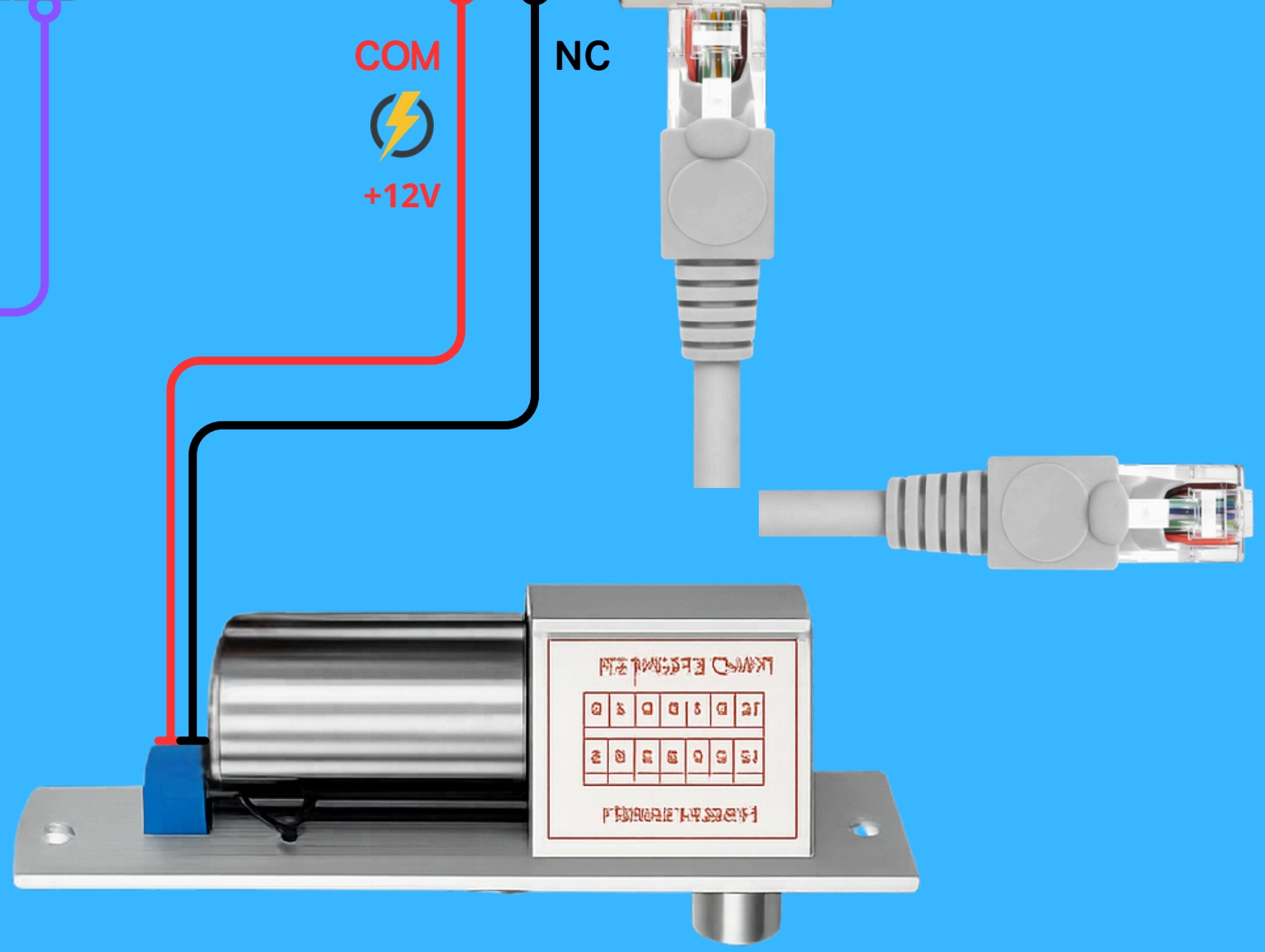
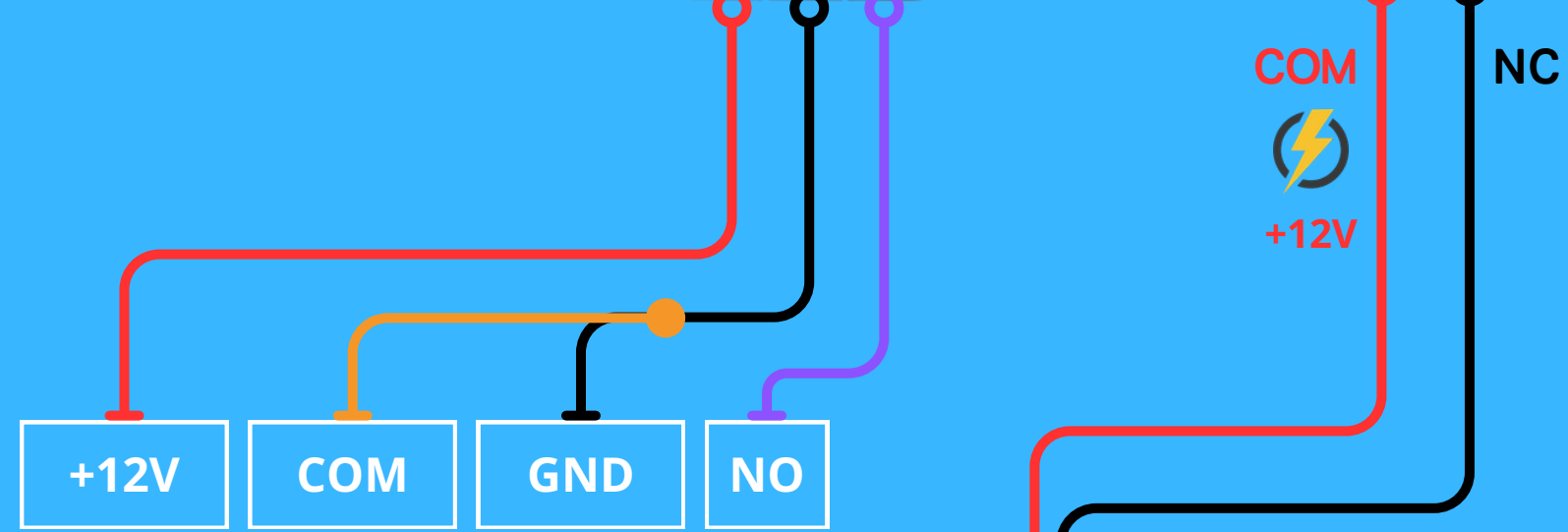
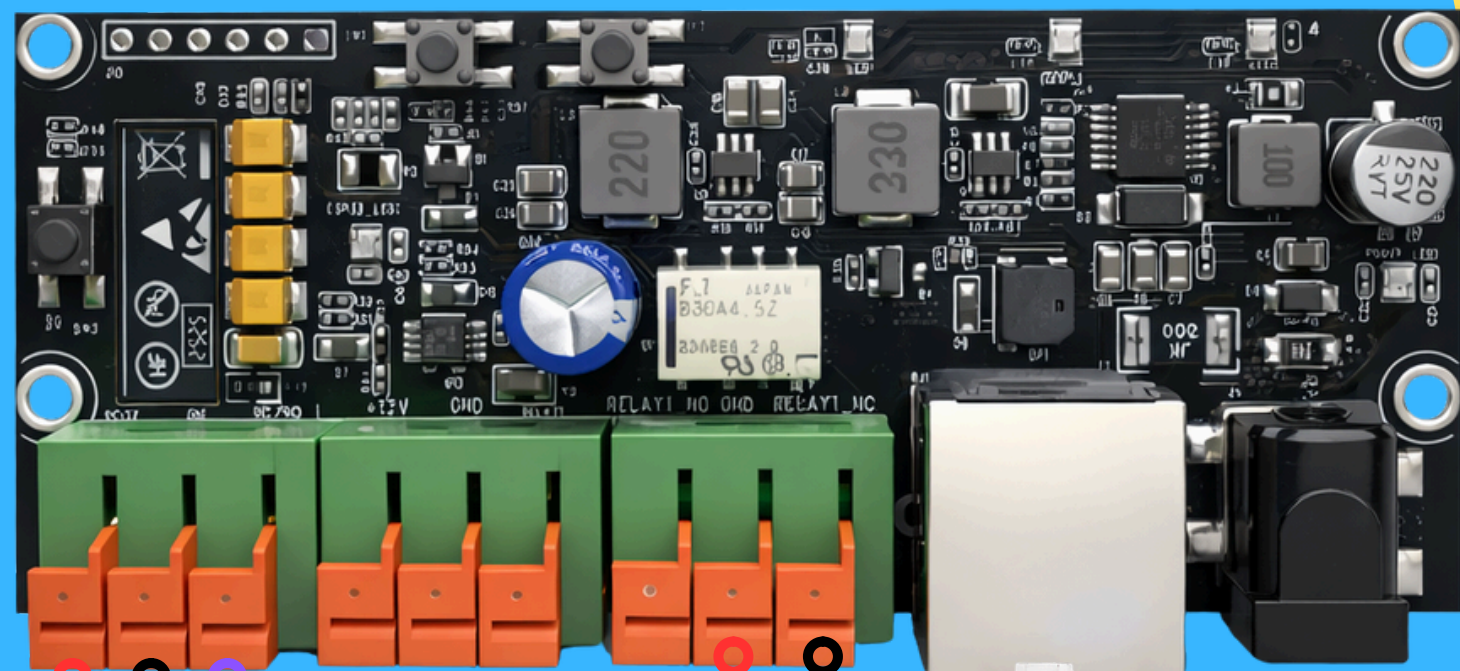

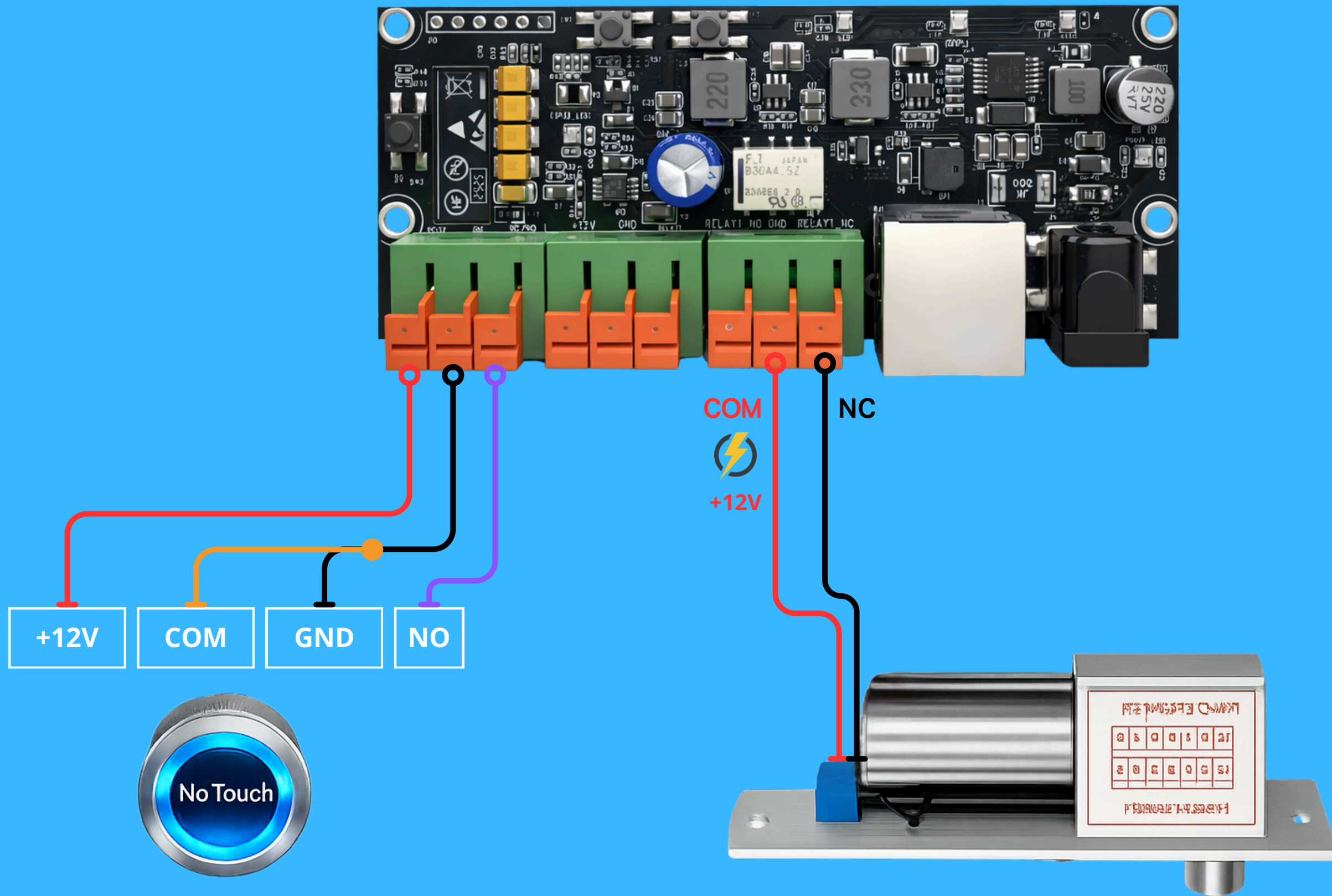

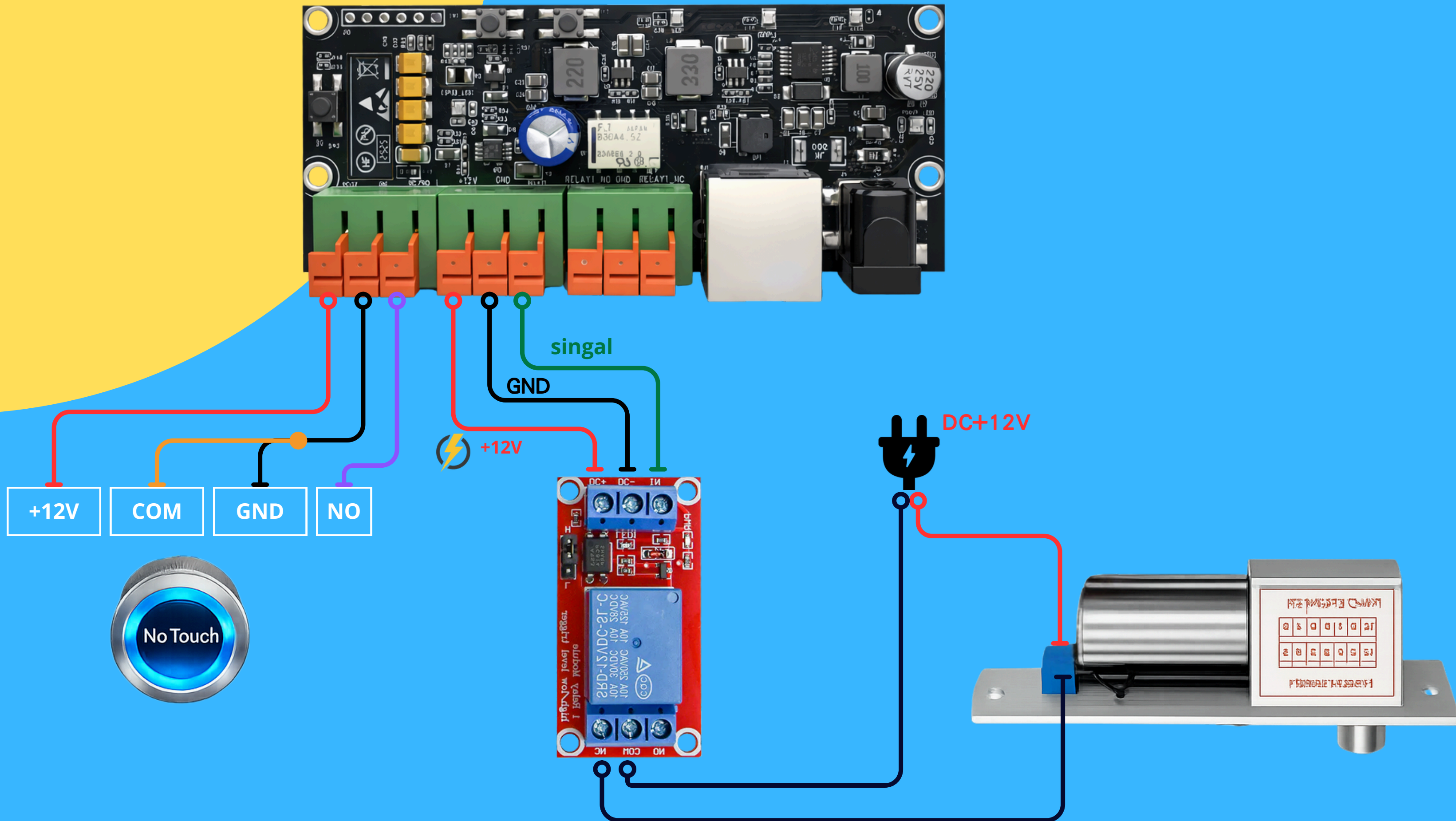

SOFTWARE

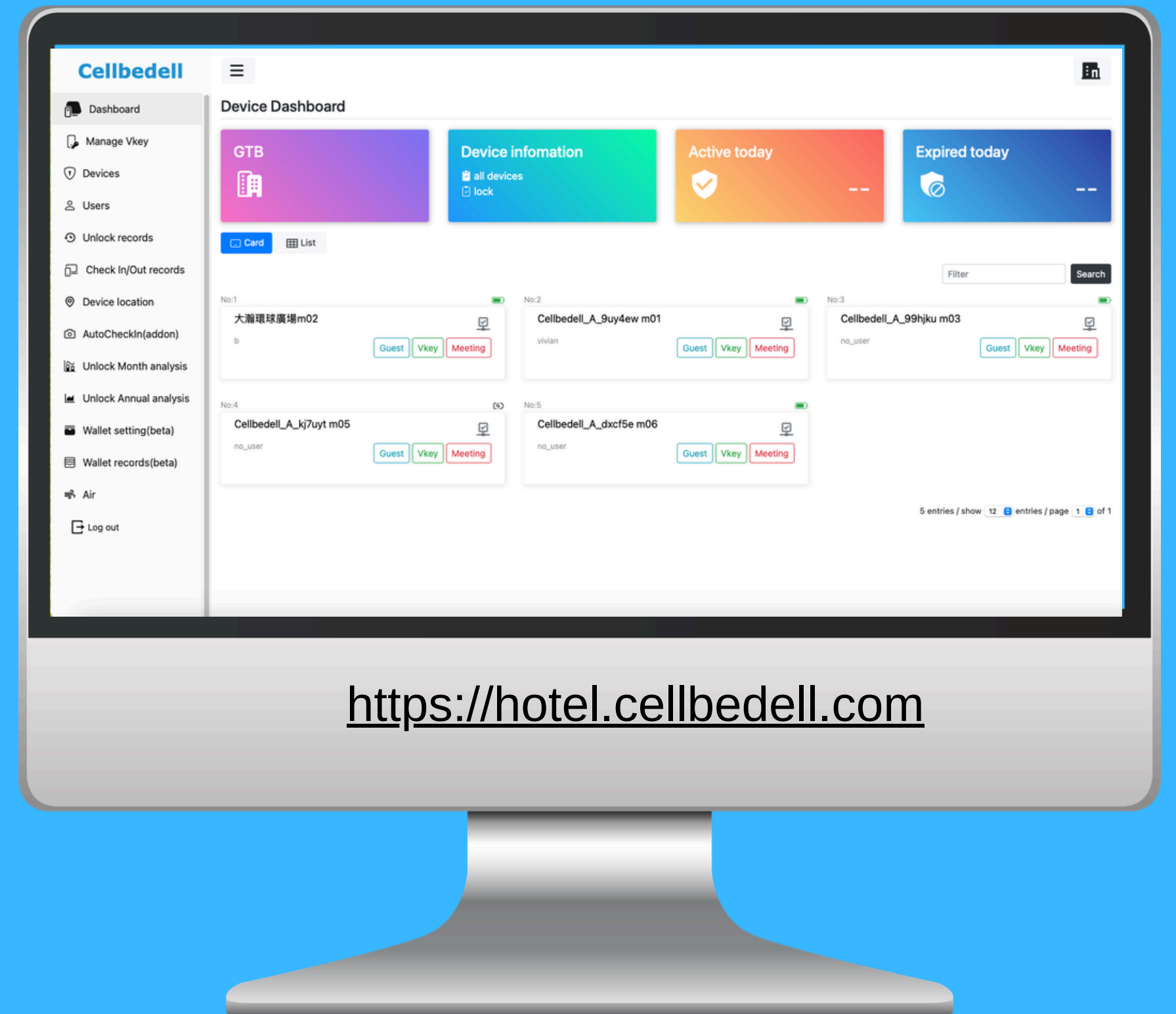
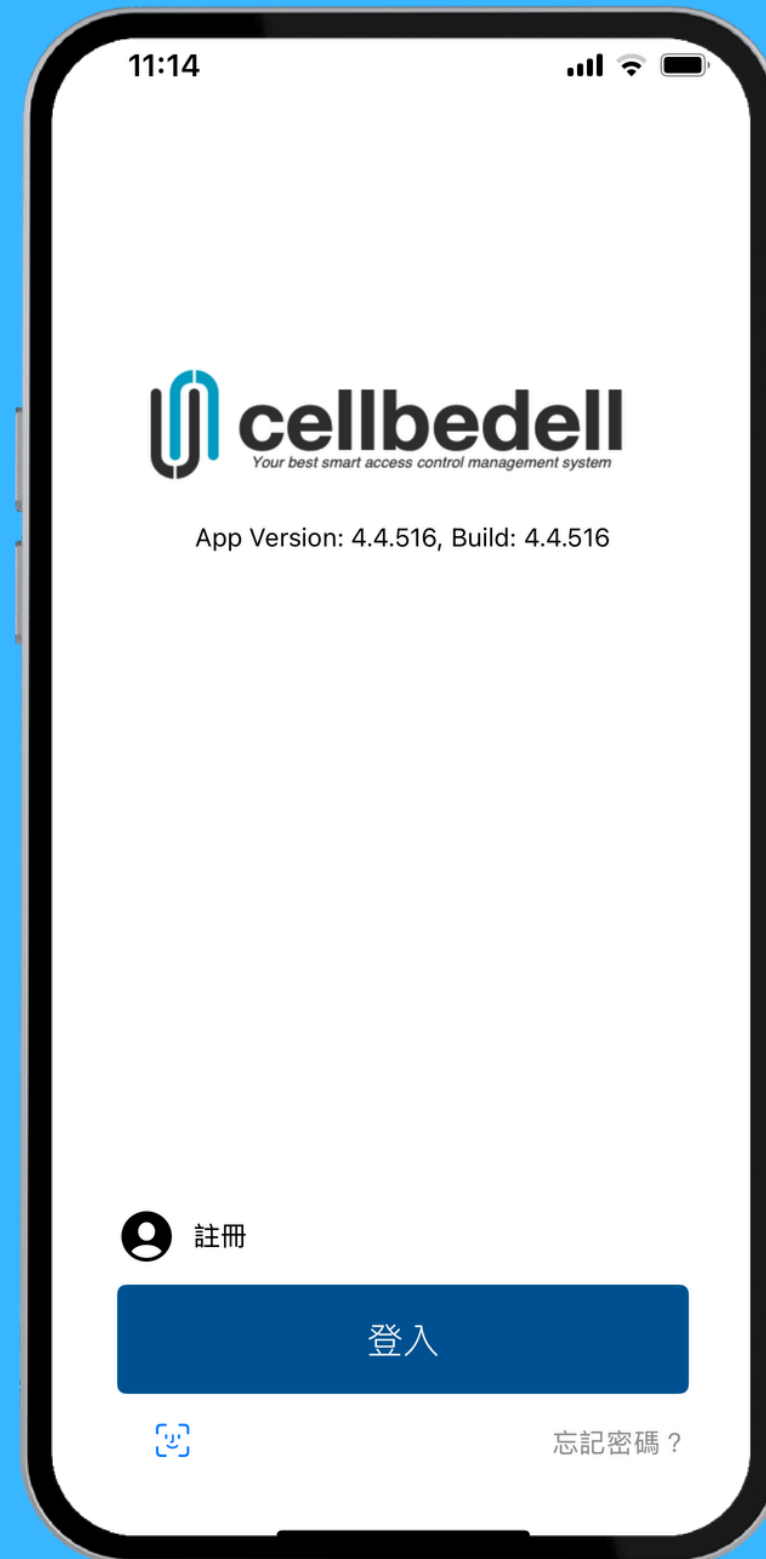

Manager

Bluetooth setting / 透過手機藍芽
即可完成設定

CellHost (管理端使用)

CellHost，功能主要是用來新增「硬體設備」
以及新增「使用人員」。
發送權限給相關人員，包含「進出金鑰」以及
「打卡金鑰」

掃描右下QRcode即可下載。



CellHost
iOS



CellHost
android

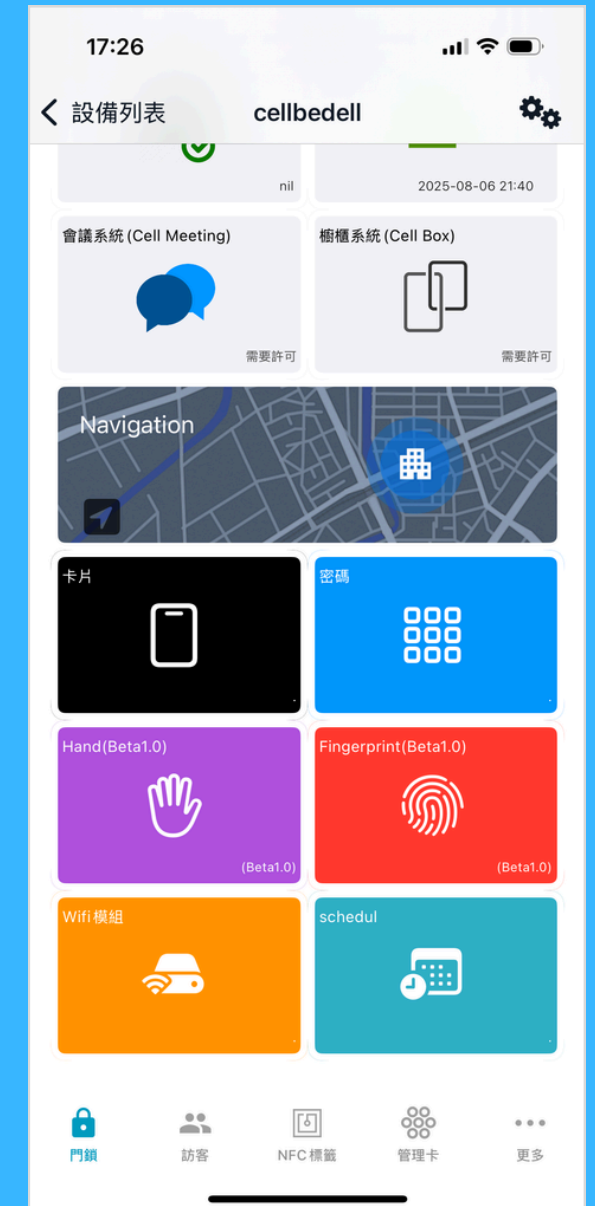

Consumer

一般用戶端使用

CellVkey (用戶端使用)

CellVkey主要是給用戶端使用功能包含

- * 打卡金鑰
- * 虛擬門禁金鑰 (搭配硬體門禁)
- * Wallet電子名片 (專案選配)

掃描右下QRcode即可下載。



CellVkey
iOS



CellVkey
android

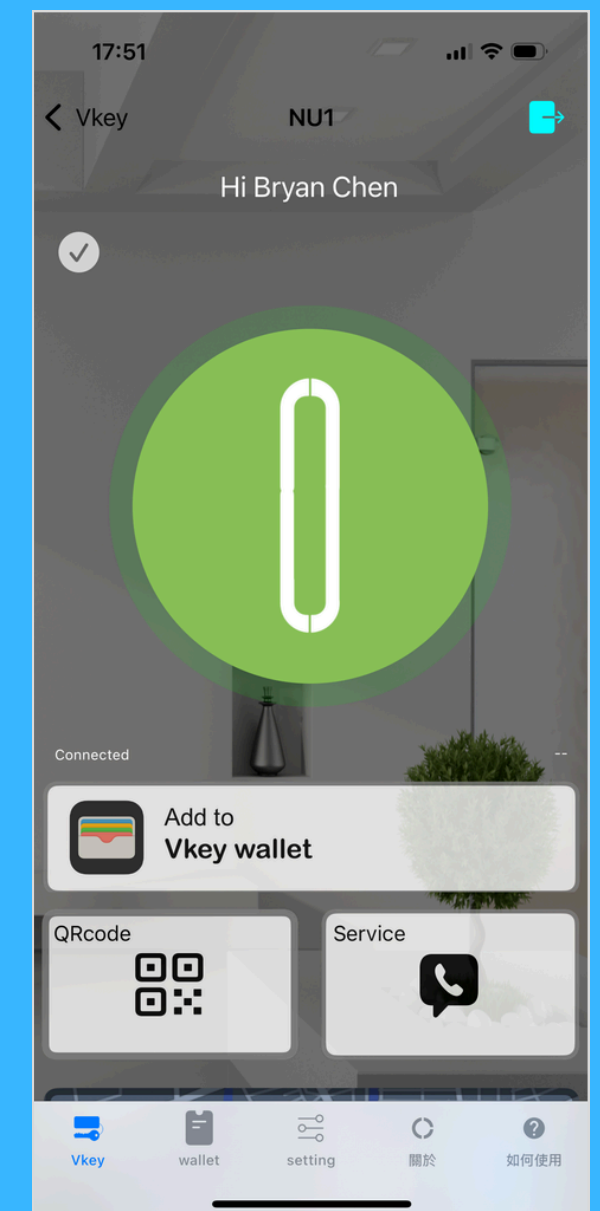
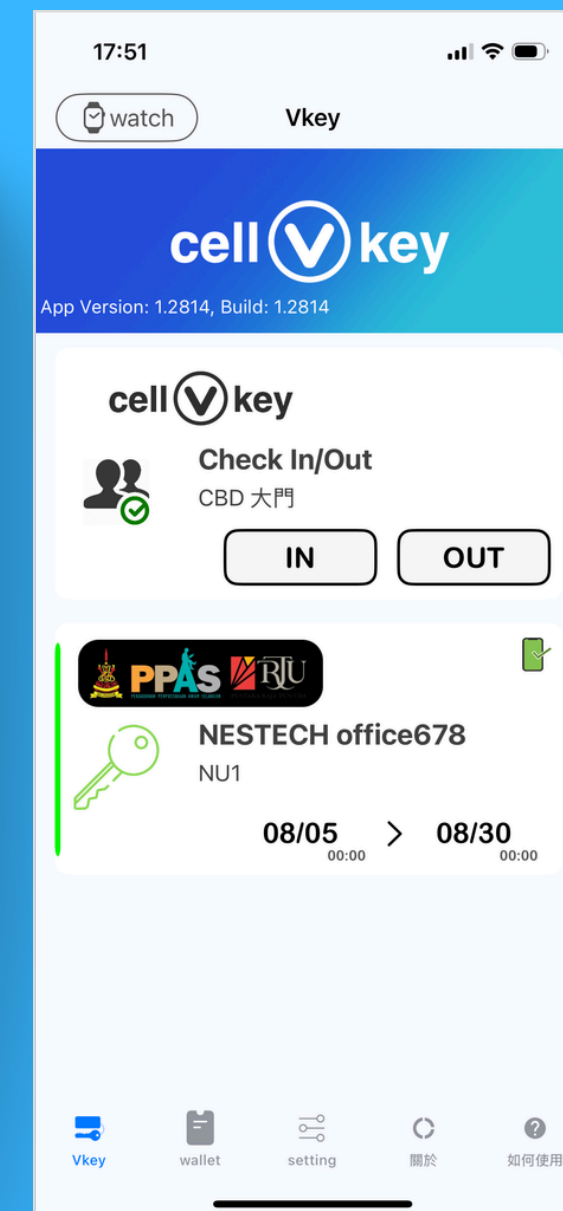
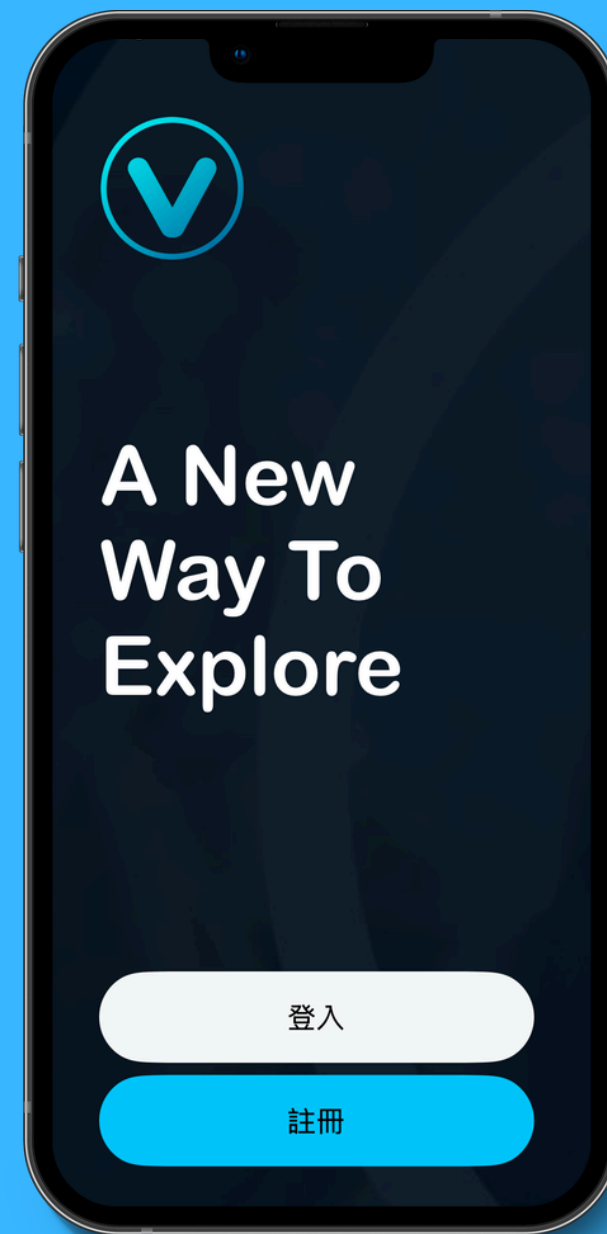

Cell Vkey

CellVkey

管理者可以依據公司LOGO以及顏色
設計公司專屬的wallet。

- ✓ wallet name card
- ✓ wallet access card
- ✓ digital key



name card

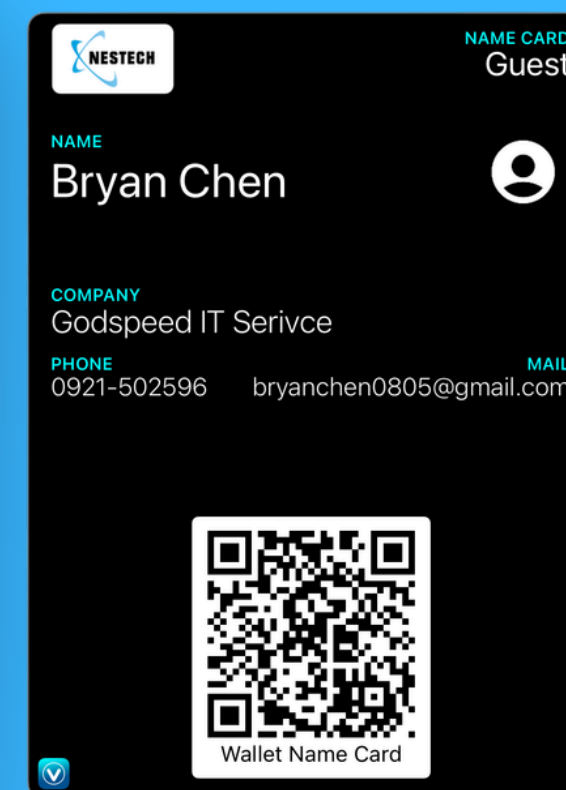

access card

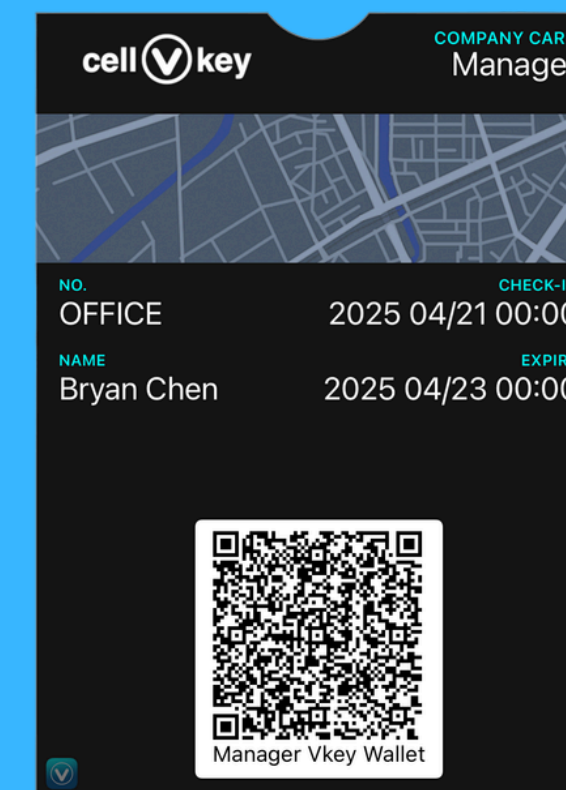

Wallet為訂閱式費用

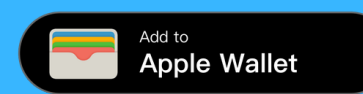

規格

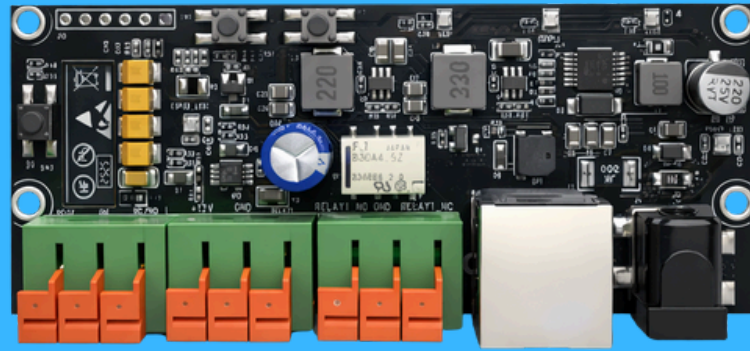

1. System Architecture

Architecture: Edge AI access controller

Design: Modular (Reader + Mainboard separated)

Deployment: Plug & Play

Installation: Wall-mounted / Surface-mounted

2. Authentication Methods

Mobile Wallet Credential (Cellbedell Vkey)

NFC (ISO14443 Type 2)

QR Code (optional module)

BLE (optional)

Biometric integration ready (future expansion)

3. Communication

PoE interface

BLE

NFC

MQTT protocol support

HTTPS RESTful API

AWS/Google Cloud

4. I/O Interface (Mainboard)

Relay Output: 1 - 2 channel

Digital Input: Door sensor / Exit button

規格

5. Power

Input Voltage: DC 12V

Power Consumption: 2A

Protection: Over-current / Reverse polarity protection

6. Appearance

Reader

Material: Industrial-grade ABS

LED status indicator

Buzzer feedback

Mainboard

Industrial PCB

實體照

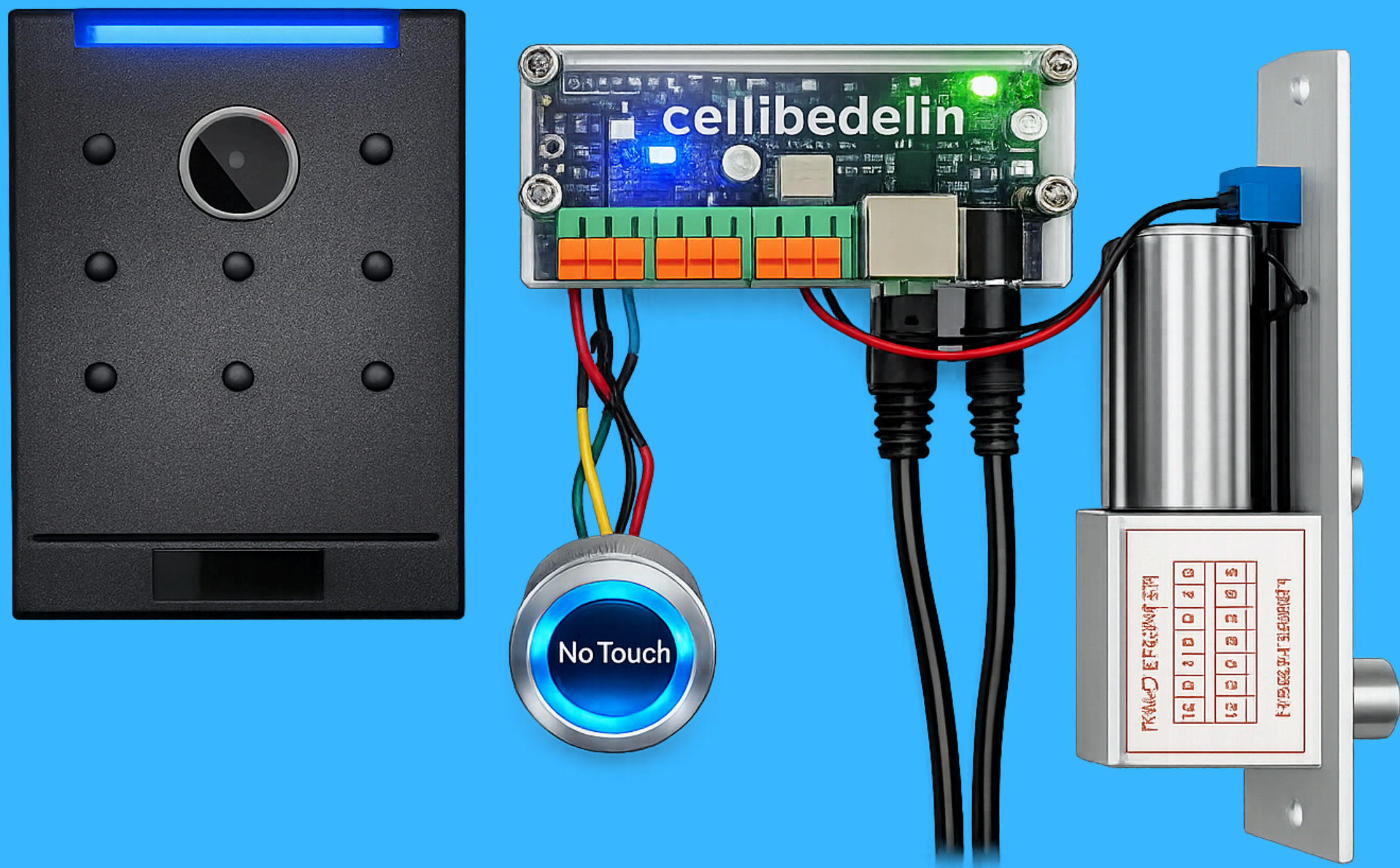

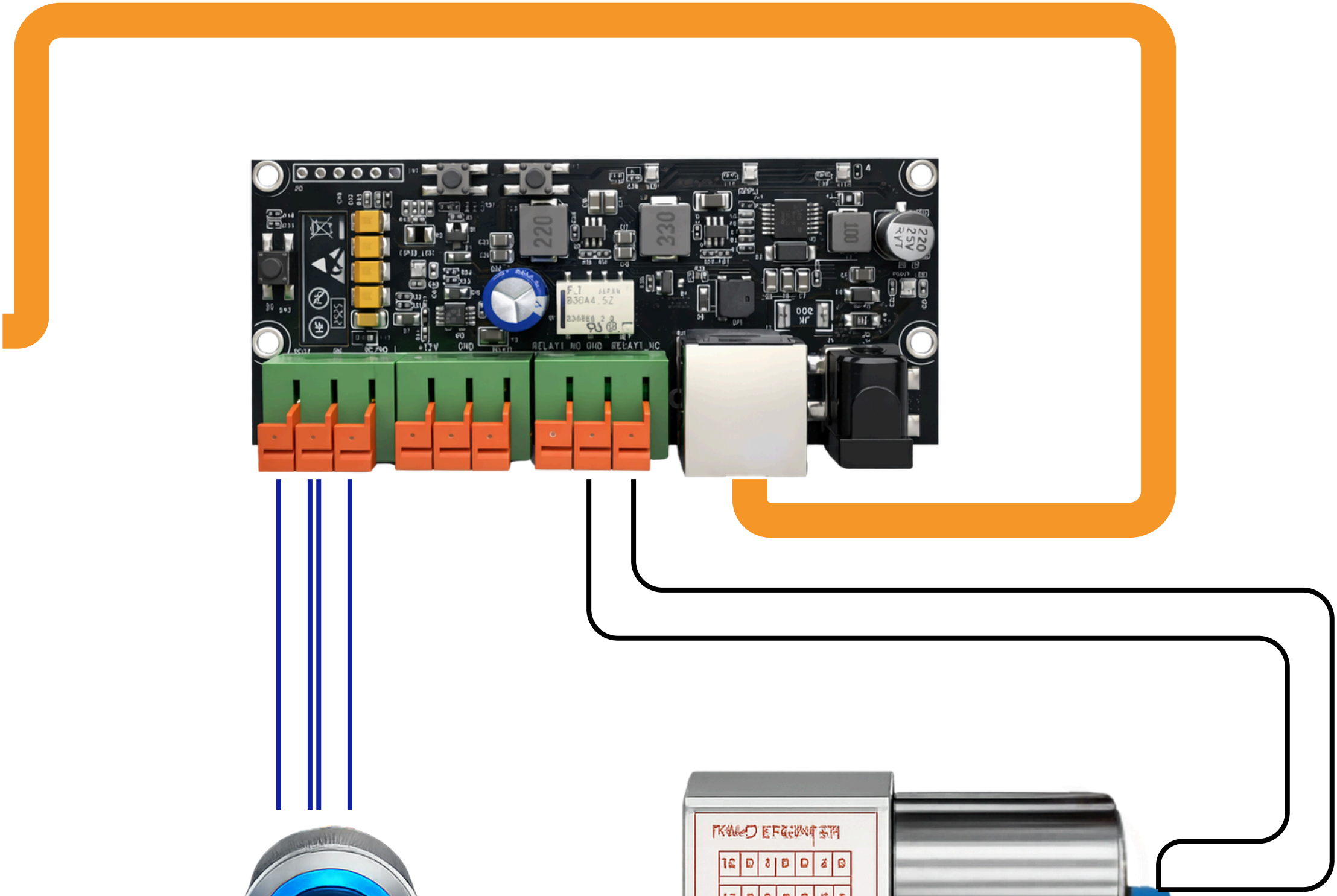
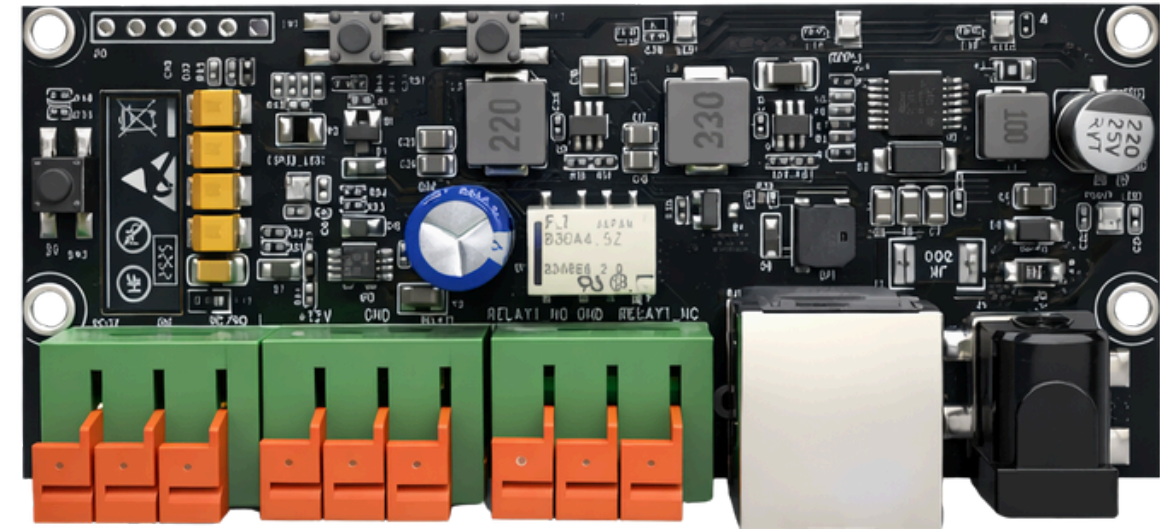

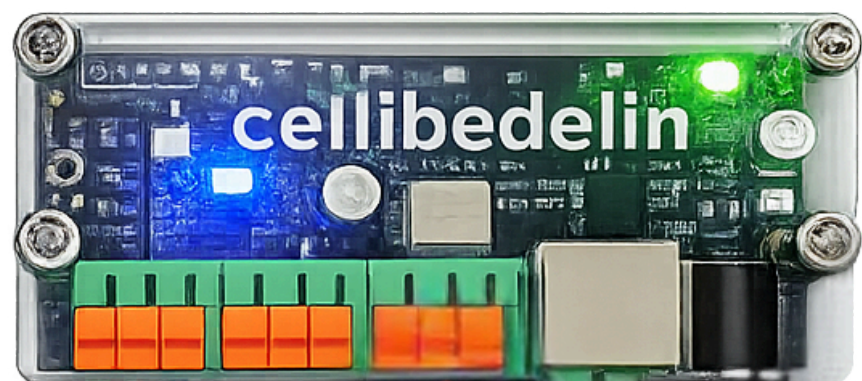

手勢開關



鎖具

POE 12Vpower adapter

Cellbedell NU1 - G2s

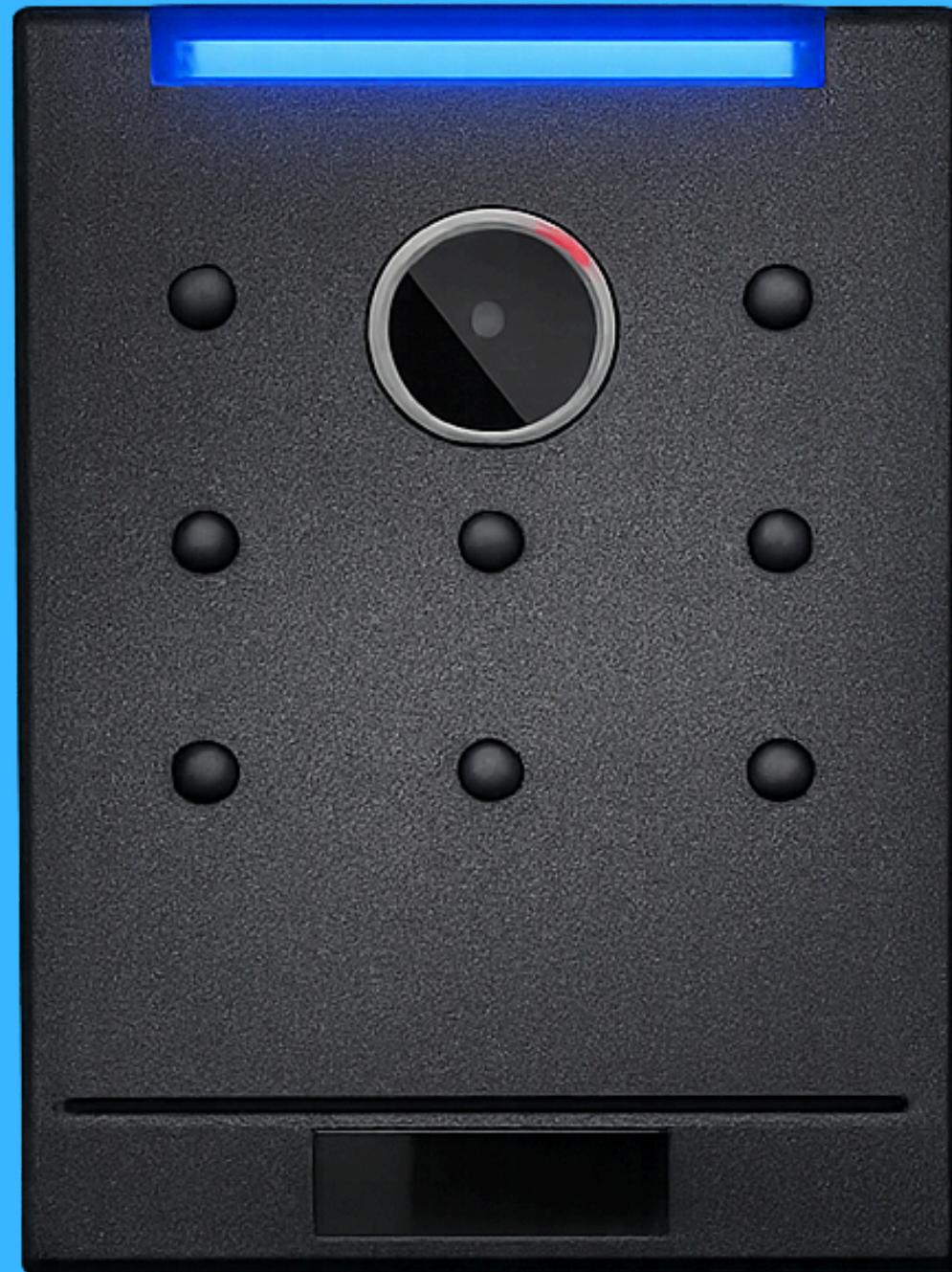

Reader

Edge AI verification

Plug and play deployment

Work both stand alone and remote

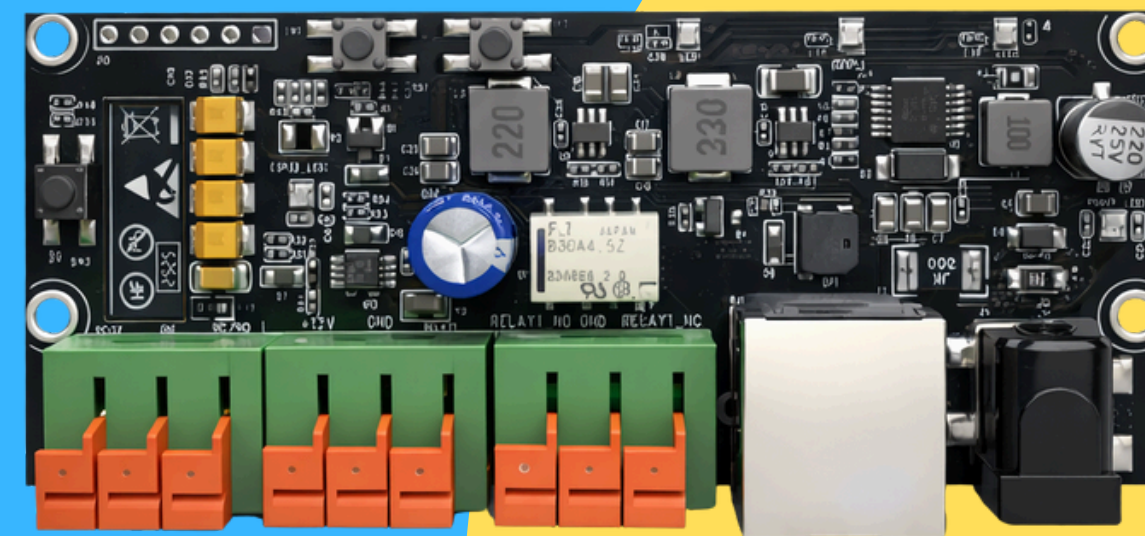

MainBoard



Manager

Bluetooth setting

CellHost (For manager usage)

CellHost is for :

- 1.new devices adding
- 2.visitor adding
- 3.Credential granting

Scan QR code to download APP



CellHost
iOS



CellHost
android

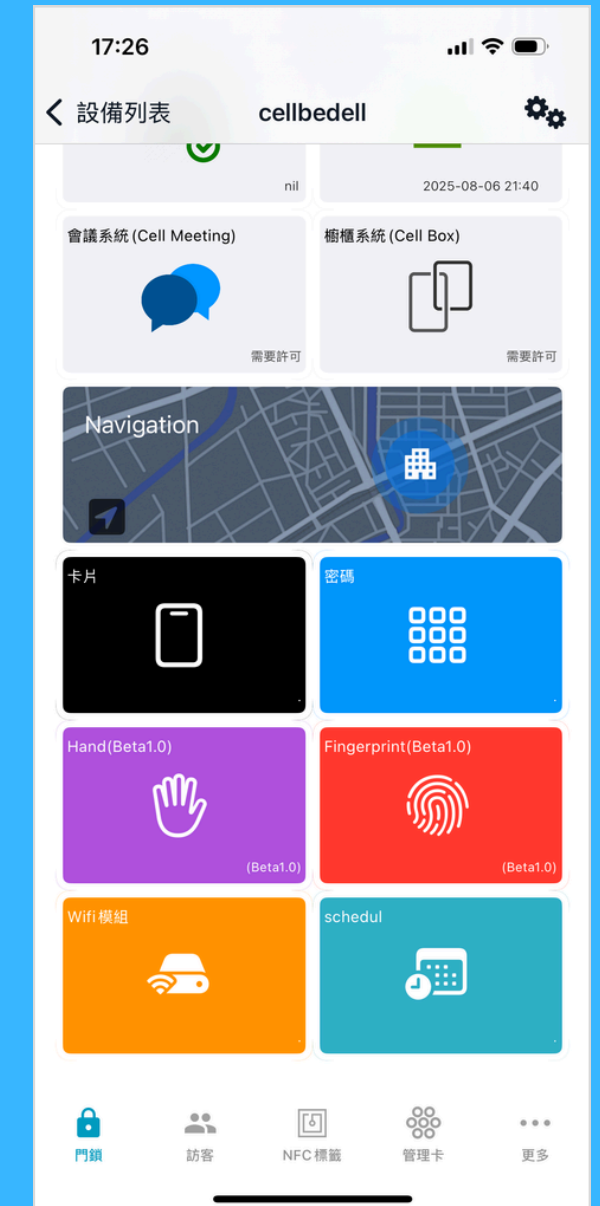

Consumer

For membership/visitors usage

CellVkey (visitors/staff/ VIP members)

CellVkey functions include:

- * Clock-in&out for staff
- * Virtual access key (paired with hardware)
- * Wallet name card/access keycard (optional)

Scan QR code to download APP



CellVkey
iOS



CellVkey
android

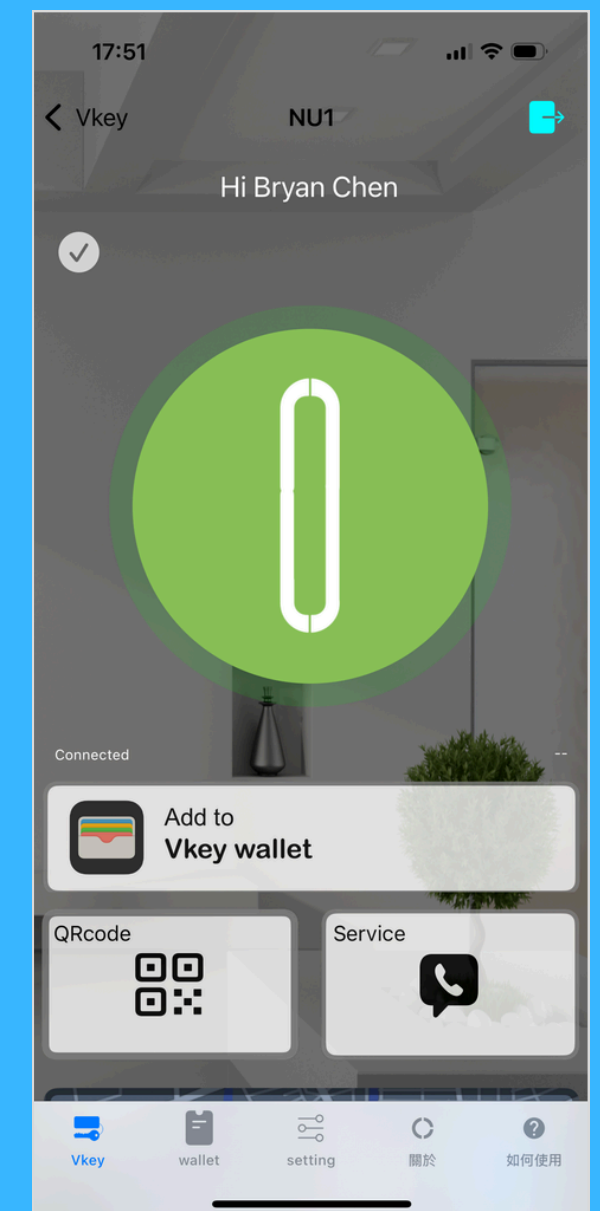
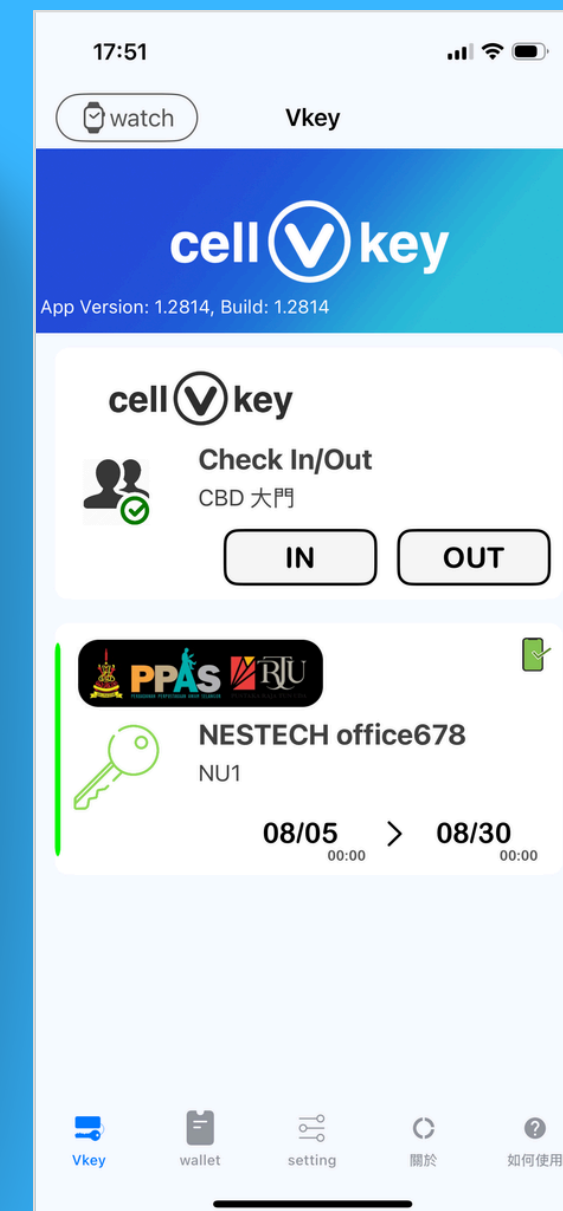
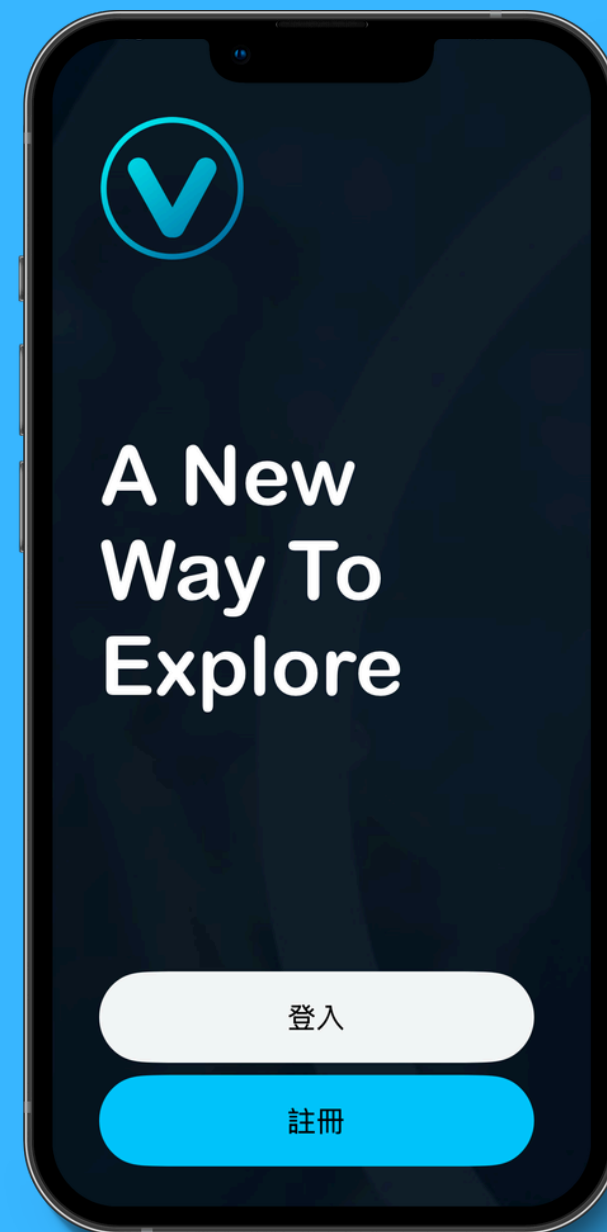

Cell Vkey

CellVkey

管理者可以依據公司LOGO以及顏色
設計公司專屬的wallet。

- ✓ wallet name card
- ✓ wallet access card
- ✓ digital key



name card

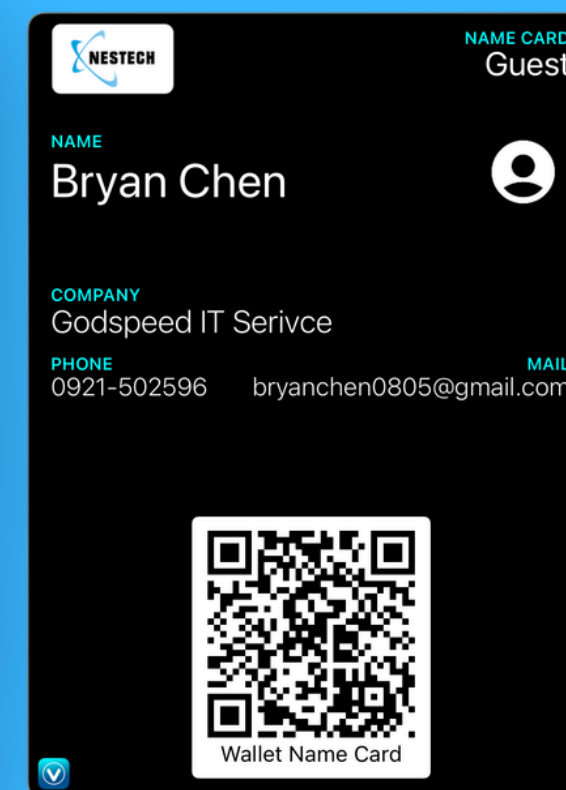

access card

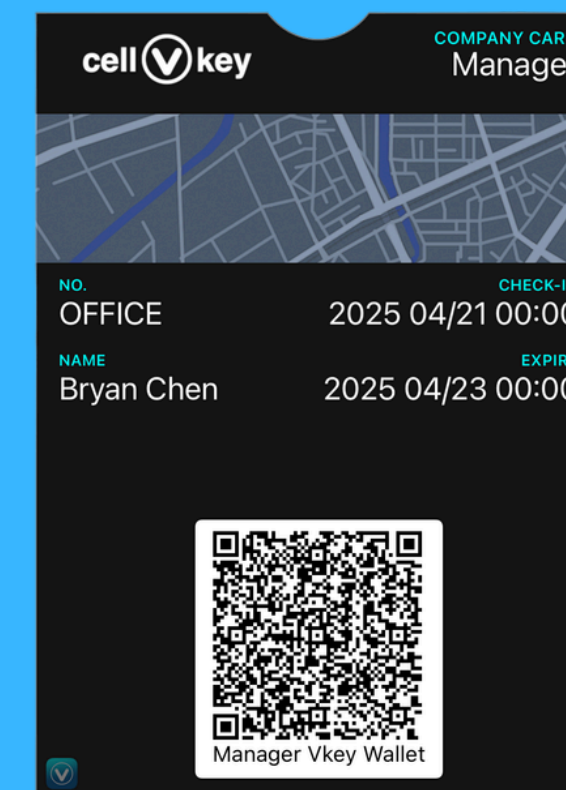

Wallet為訂閱式費用

